

Document Name CN 4 & 6 Installation Instruction	Template Number GSPDPAD46	Document Number PDPAD460000668
Document Owner ESS Department	Template Rev 01	Document Rev AA001



BEFORE YOU BEGIN

Read these instructions completely and carefully. Save these instructions for future use.

⚠ WARNING

Risk of electrical shock. Disconnect power before servicing or installing luminaire.

⚠ WARNING

Risk of injury or damage. Luminaire will fall if not installed properly. Follow installation instructions.

⚠ WARNING

Risk of injury. Wear safety glasses and gloves during installation and servicing.

Important Notice

These instructions are not intended to cover all details or variations in the products nor do these instructions provide for every possible contingency concerning the installation, operations, or maintenance of the luminaire. Should additional information be required, contact your Greenstar Products Inc.

The contents of this manual shall not become a part of or modify any prior or existing agreement, commitment, or relationship. The sales contract contains the entire obligation of Greenstar Products Inc. Greenstar Products Inc.'s standard limited warranty is the sole warranty obligation of Greenstar Products Inc. and any statements contained herein do not create new warranties or modify the existing warranty.

Any electrical or mechanical modifications to the luminaire without the prior written consent of Greenstar Products Inc. may void all warranties or other safety certifications. Unauthorized modifications may also result in safety hazards or damage to the luminaire. Misuse of the luminaire could result in injury and equipment damage. In no event will Greenstar Products Inc. be responsible or liable for direct, indirect, special, or consequential damage or injury that may result from the misuse of the luminaire.

PRODUCT DIMENSIONS

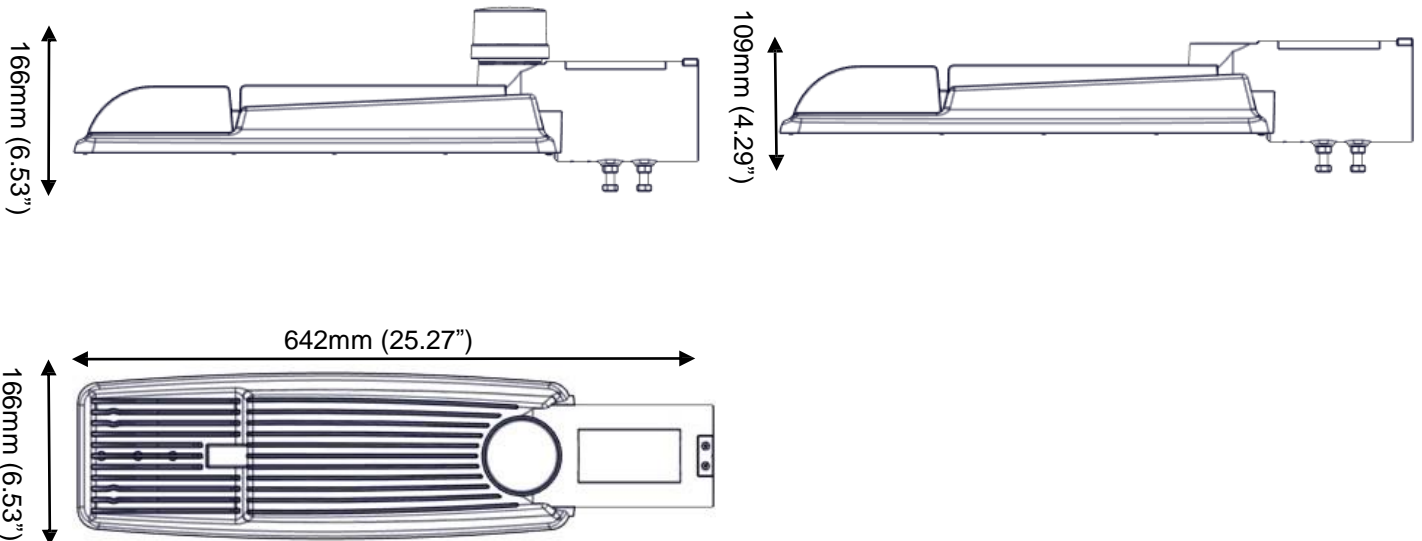

Document Name CN 4 & 6 Installation Instruction	Template Number GSPDPAD46	Document Number PDPAD460000668
Document Owner ESS Department	Template Rev 01	Document Rev AA001

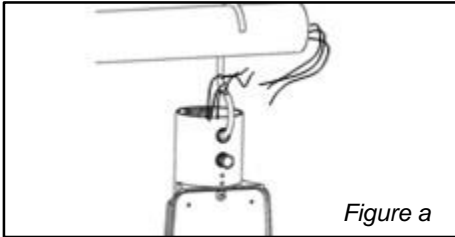

Figure a

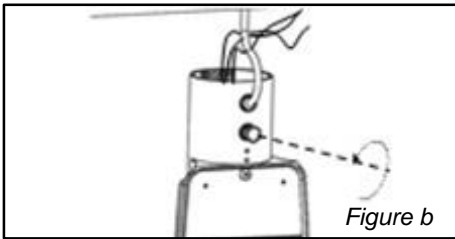

Figure b

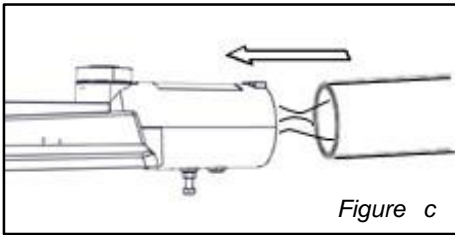

Figure c

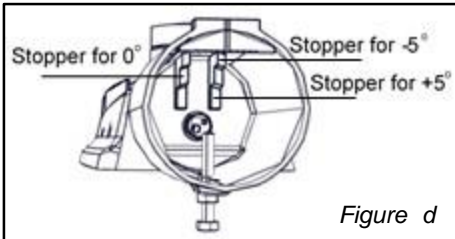

Figure d

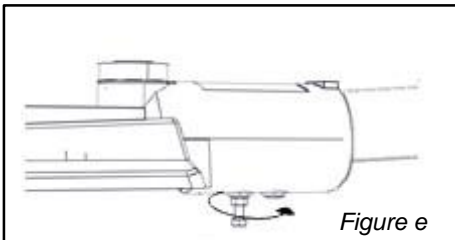

Figure e

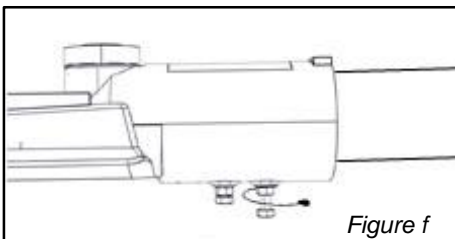

Figure f

Inspection

- The packaging has been designed to protect the luminaire from damage during transit. Inspect luminaire for damage before installation.

Mounting the Luminaire on the Pole

- Hang the LED Fixture using a Hook Arrangement. Do NOT Leave Ground Disconnected. (see figure a).

Wiring

- NOTE:** Make sure that all electrical connections are in accordance with the National Electrical Code (NEC), and any applicable local code requirements.
- NOTE:** Check the rated input voltage on the luminaire product label, and verify that the supply voltage meets the product requirements.
- Connect wire leads as follows—
 - CONNECT WHITE (neutral) supply wire to white luminaire wire.
 - CONNECT RED (live) supply wire to red luminaire wire.
 - CONNECT GREEN (ground) supply wire to green luminaire wire.
- When making electrical connections, make sure that the ground wire on the supply side is connected to the ground wire of the luminaire. Under no circumstances the ground wire should be left disconnected. This will cause the luminaire to fail, and the luminaire will not be covered under warranty.

- Loosen the fasteners. Make sure fasteners are still holding thread and NOT completely dislodged. (see figure b).

- Unhook the luminaire and rest the pole part of the luminaire onto the pole.

- For -5° tilt, slide the luminaire till it is stopped by the stopper provided and rest on the adaptor (see figure c and d).
- For 0° tilt, slide the luminaire and lift the luminaire slightly so that it rest on the 0° step provided will the help of adaptor.
- For 5° tilt, slide the luminaire and lift the luminaire slightly so that it rest on the 5° step provided will the help of adaptor.

- Manual tighten fastener to lock vertical rotation of luminaire. (see figure e).

- Screw in other Fastener in similar fashion. (see figure f).

- Alternately tighten both screws to avoid loosening due to vibrations.

- Torque Value

Maintenance

- Depending on environmental conditions it may be necessary to clean the lens in order to maintain a high-efficiency lens. (Use solvent-free cleaners)

Storage

- Prior to installation, the luminaire should be placed in a covered, dry storage. The storage location should not exceed the normal operating temperature of the luminaire.